



EBARA

CS1330EE

PROCESS PUMPS

Two Stage, Centerline Support

Models

R2, R2D **API 610** **API 682**

※ 「Model ○○○」 in this catalog is our model code.

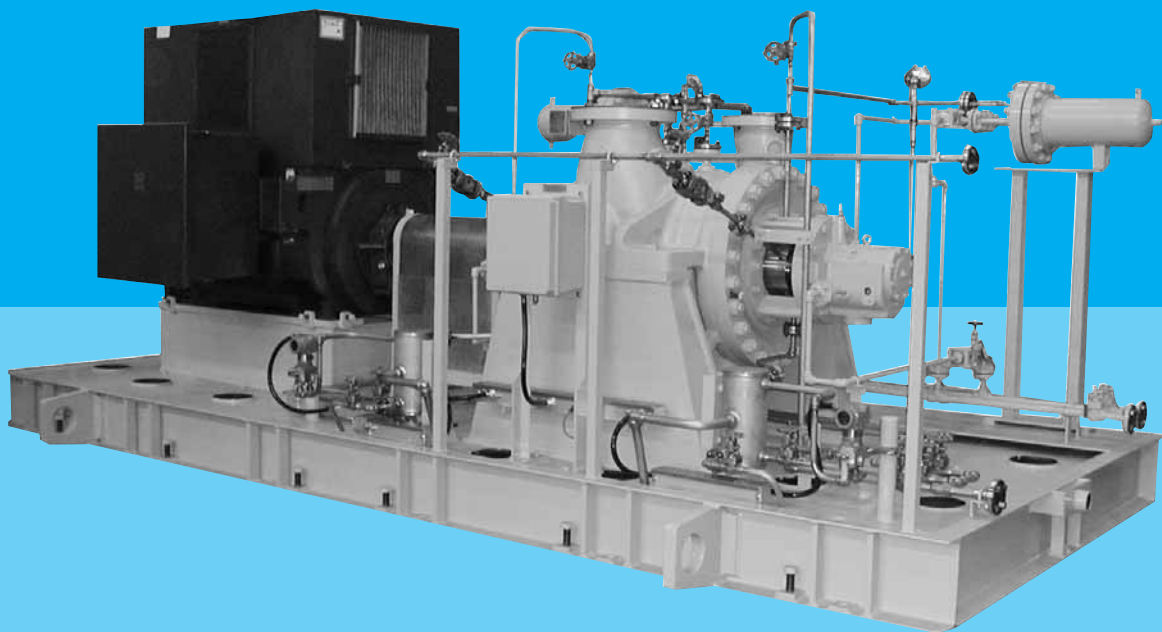

PROCESS PUMPS

Two Stage, Centerline Support

Model

R2/R2D

API 610 API 682

Over the past years, Ebara's centerline support type horizontal two stage process pumps have earned a good reputation on a field-proven basis for the oil refining, petrochemical and chemical industries. To meet your uncompromising requirements for plant use, R2 and R2D two stage process pumps has been improved under API 610

standards with higher lift and efficiency. Our modern tape controlled machines in conjunction with advanced quality control procedures insure that these pumps meet our high manufacturing standards. Unique design of this high performance pump provides for superior and extended low-cost installation and operation.

Model R2
Horizontal, two stage, single suction, between bearing, centerline support type.
Model R2D
Horizontal, two stage, double suction first stage, between bearing, centerline support type.

Applications

- Petroleum Refineries
- The Petrochemical Industry
- Chemical Industries
- Other high temperature & high pressure uses

Ratings

Capacities	To 1500m ³ /h (6600 USGPM)
Heads	To 520m (1700ft)
Max. Working pressures	Consistent with the pressure ratings of ANSI class 300 flanges. High pressure ratings are available.
Rotation	Clockwise (viewed from inboard side)
Impeller type	Enclosed
Temperature range	-100°C to 450°C (-150°F to 850°F)
Flange	ANSI 300 as standard
Nozzle	Top-Top
Stuffing box	Suitable for mechanical seal & conventional packing

Features

- Centerline support and heavy duty design.
- Full compliance with API 610 and API 682 specifications.
- All components have been designed for maximum parts interchangeability.
- Low NPSH performance.

Designation

SINGLE SUCTION 1st STAGE IMPELLER DESIGN

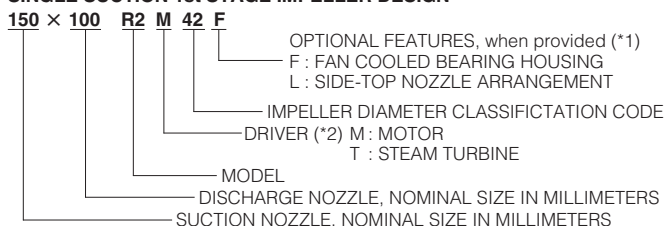

DOUBLE SUCTION 1st STAGE IMPELLER DESIGN

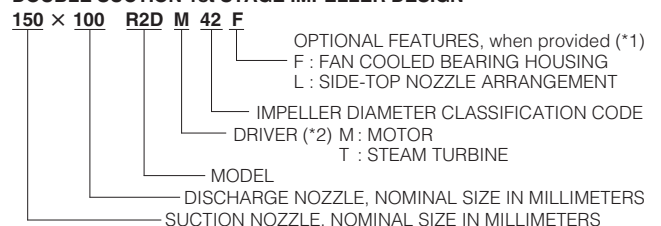

NOTES : (*1) When two features are involved, the codes are in alphabetical order.

(*2) When a step up or step down gear is provided, the code letter "G" is added between model and driver.

For example, 150 × 100 R2GM means that the pump is driven by an electric motor through a separate gear.

Construction

Model R2

Casing : The volute type casing is designed to maintain high efficiency over long periods of wear. Radially split casing and centerline support construction effectively reduces the thermal effects.

Impeller : Enclosed impellers are designed for maximum efficiency. Both the impeller and casing have easily replaceable case wear ring and impeller wear ring.

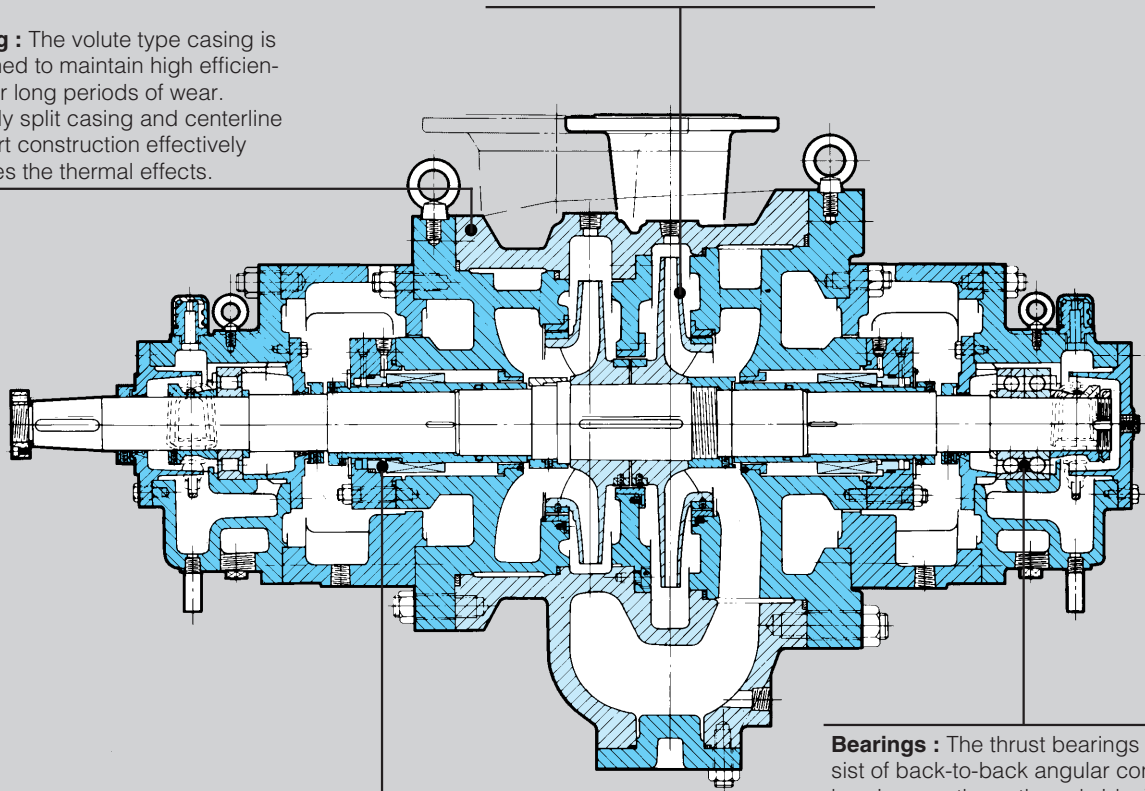

Shaft Sealing : Mechanical seals are available from any mechanical seal maker. Alternately, a deep ring stuffing box with six rings of packing plus one lantern ring can be applied.

Bearings : The thrust bearings consist of back-to-back angular contact bearings on the outboard side. The cylindrical roller radial bearing (or sleeve metal) on the inboard side assures normal operation during differential expansion. These bearings are lubricated by an oil ring. Bearing construction are also available sleeve, or pivoted shoe.

Metallurgy

Part Name	Materials JIS/ASTM-AISI				
	C. Steel	C. Steel	12%Cr. Steel	304 S. Steel	316 S. Steel
Casing	SCPH2/A216WCB	SCPL1/A352LCB	SCS1/A487CA6NM	SCS13A/A351CF8	SCS14A/A351CF8M
Impeller 1st STG	SCS1/A487CA6NM	SCS13A/A351CF8	SCS1/A487CA6NM	SCS13A/A351CF8	SCS14A/A351CF8M
Impeller 2nd STG	SCS1/A487CA6NM	SCS13A/A351CF8	SCS1/A487CA6NM	SCS13A/A351CF8	SCS14A/A351CF8M
Shaft	SCM440/AISI4140	SUS304/AISI304	SUS420J1/AISI420	SUS304/AISI304	SUS316/AISI316
Impeller Wear Ring	SUS420J2/AISI420	SUS304/AISI304	SUS420J2/AISI420	SUS304/AISI304	SUS316/AISI316
Case Wear Ring	SUS420J1/AISI420	SUS304/AISI304	SUS420J1/AISI420	SUS304/AISI304	SUS316/AISI316
Sleeve for Packing	SUS420J2/AISI420	SUS304/AISI304	SUS420J2/AISI420	SUS304/AISI304	SUS316/AISI316
Sleeve for Mechanical Seal	SUS420J2/AISI420	SUS304/AISI304	SUS420J2/AISI420	SUS304/AISI304	SUS316/AISI316

Notes : Following materials supplied on request : 304L S. Steel, 329J1S. Steel, Hastelloy, 20 Alloy, Monel.

Standard Materials
 Optional Materials

Construction

Model R2D

Casing : The volute type casing is designed to maintain high efficiency over long periods of wear. Radially split casing and centerline support construction effectively reduces the thermal effects.

Impeller : Enclosed impellers are designed for maximum efficiency. Both the impeller and casing have easily replaceable case wear ring and impeller wear ring. Double suction first stage impeller reduces NPSH requirements.

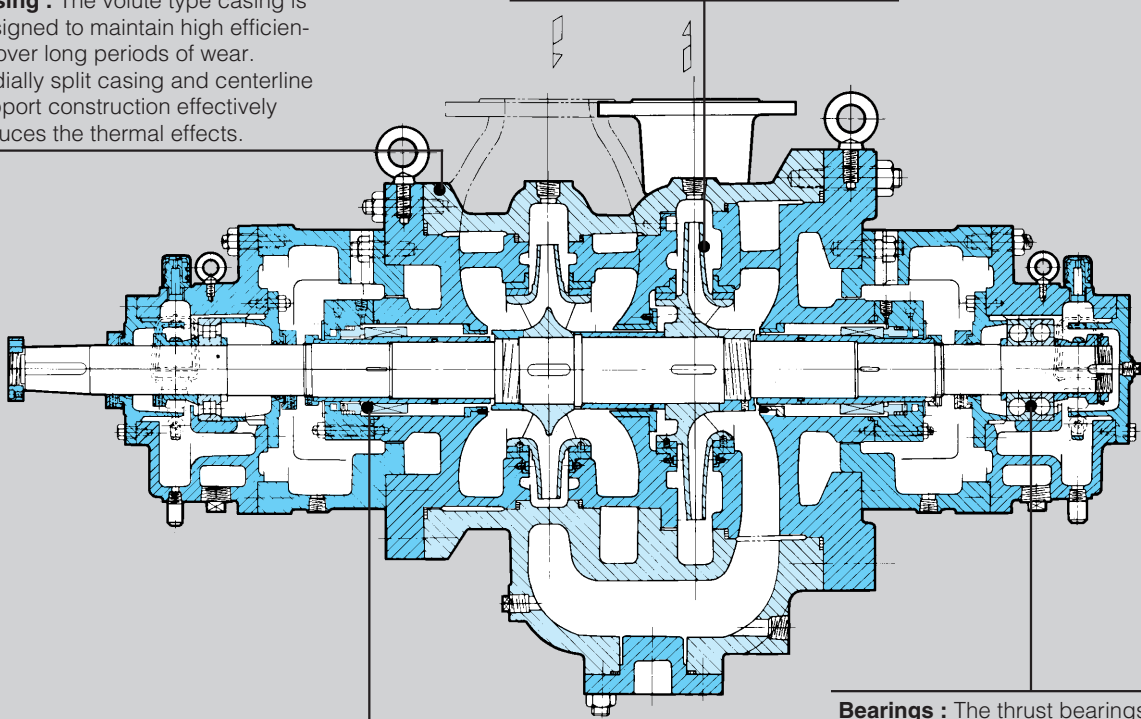

Shaft Sealing : Mechanical seals are available from any mechanical seal maker. Alternately, a deep ring stuffing box with six rings of packing plus one lantern ring can be applied.

Bearings : The thrust bearings consist of back-to-back angular contact bearings on the outboard side. The cylindrical roller radial bearing (or sleeve metal) on the inboard side assures normal operation during differential expansion. These bearings are lubricated by an oil ring. Bearing construction are also available sleeve, or pivoted shoe.

Metallurgy

Part Name	Materials JIS/ASTM-AISI				
	C. Steel	C. Steel	12%Cr. Steel	304 S. Steel	316 S. Steel
Casing	SCPH2/A216WCB	SCPL1/A352LCB	SCS1/A487CA6NM	SCS13A/A351CF8	SCS14A/A351CF8M
Impeller 1st STG	SCS1/A487CA6NM	SCS13A/A351CF8	SCS1/A487CA6NM	SCS13A/A351CF8	SCS14A/A351CF8M
Impeller 2nd STG	SCS1/A487CA6NM	SCS13A/A351CF8	SCS1/A487CA6NM	SCS13A/A351CF8	SCS14A/A351CF8M
Shaft	SCM440/AISI4140	SUS304/AISI304	SUS420J1/AISI420	SUS304/AISI304	SUS316/AISI316
Impeller Wear Ring	SUS420J2/AISI420	SUS304/AISI304	SUS420J2/AISI420	SUS304/AISI304	SUS316/AISI316
Case Wear Ring	SUS420J1/AISI420	SUS304/AISI304	SUS420J1/AISI420	SUS304/AISI304	SUS316/AISI316
Sleeve for Packing	SUS420J2/AISI420	SUS304/AISI304	SUS420J2/AISI420	SUS304/AISI304	SUS316/AISI316
Sleeve for Mechanical Seal	SUS420J2/AISI420	SUS304/AISI304	SUS420J2/AISI420	SUS304/AISI304	SUS316/AISI316

Notes : Following materials supplied on request : 304L S. Steel, 329J1S. Steel, Hastelloy, 20 Alloy, Monel.

Standard Materials
 Optional Materials

Performance Ranges

Model R2

50Hz

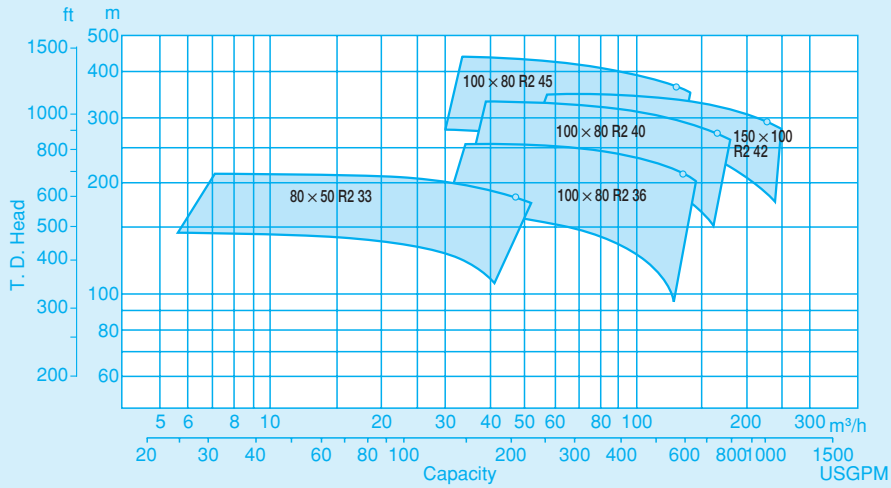

Model R2D

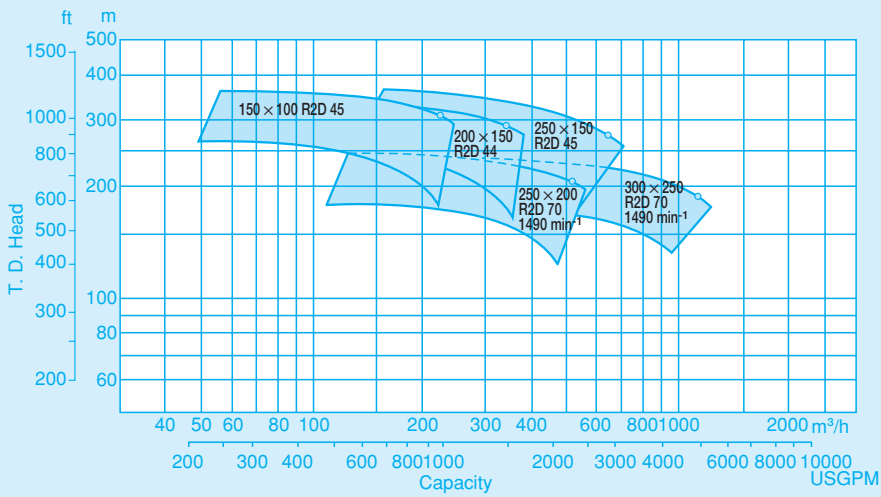

General Process Pumps

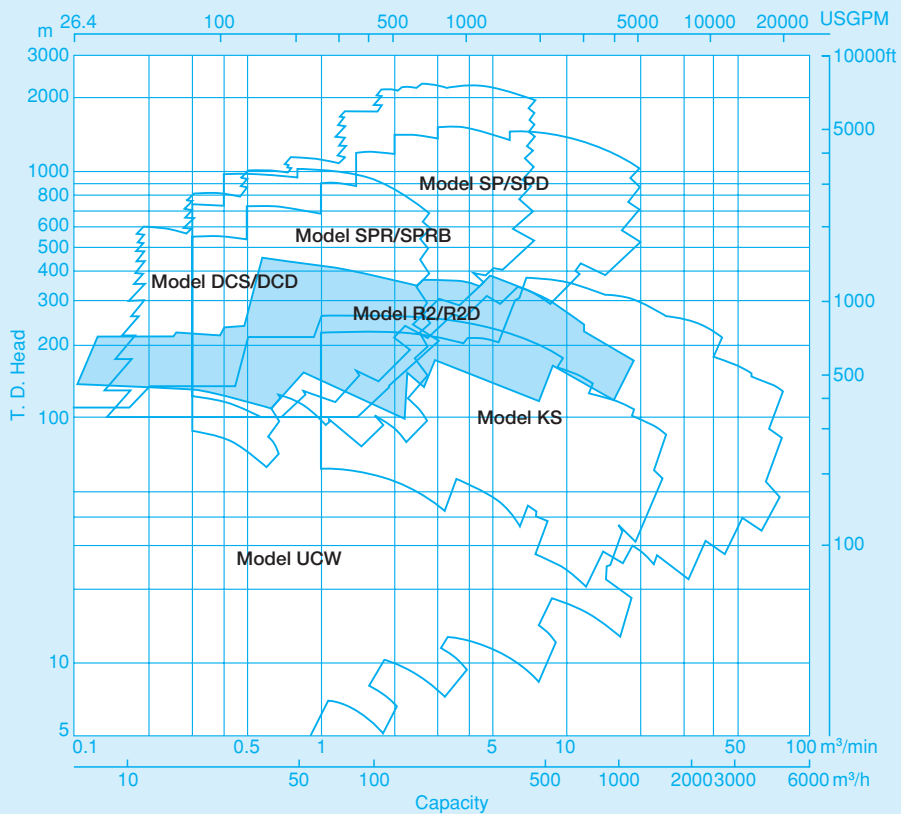

Performance ranges shown on these charts are for preliminary selection only.

Performance Ranges

Model R2

60_{Hz}

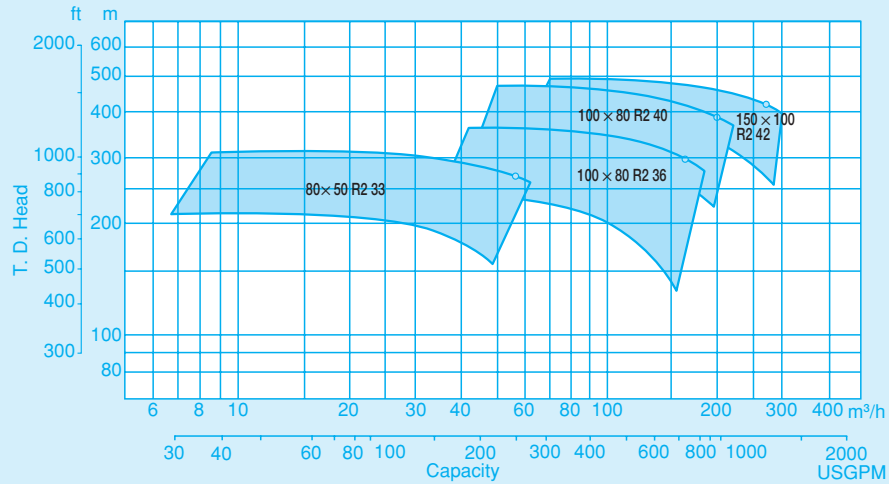

Model R2D

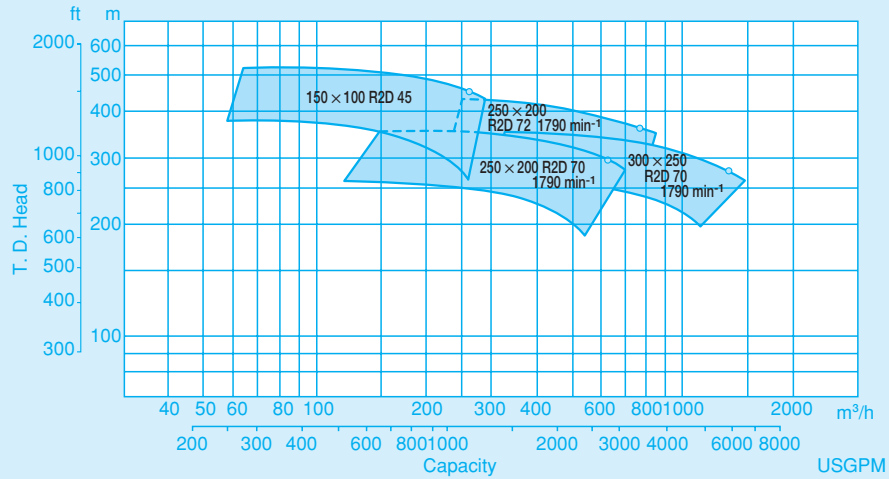

General Process Pumps

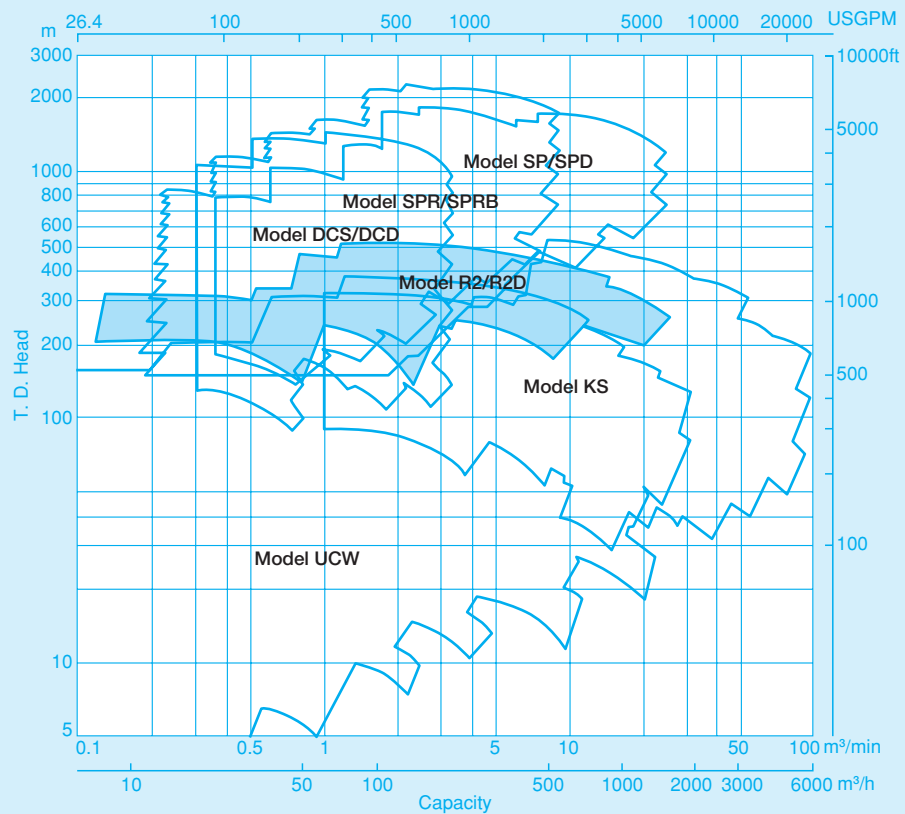

Performance ranges shown on these charts are for preliminary selection only.

Dimensions

Model R2, R2D

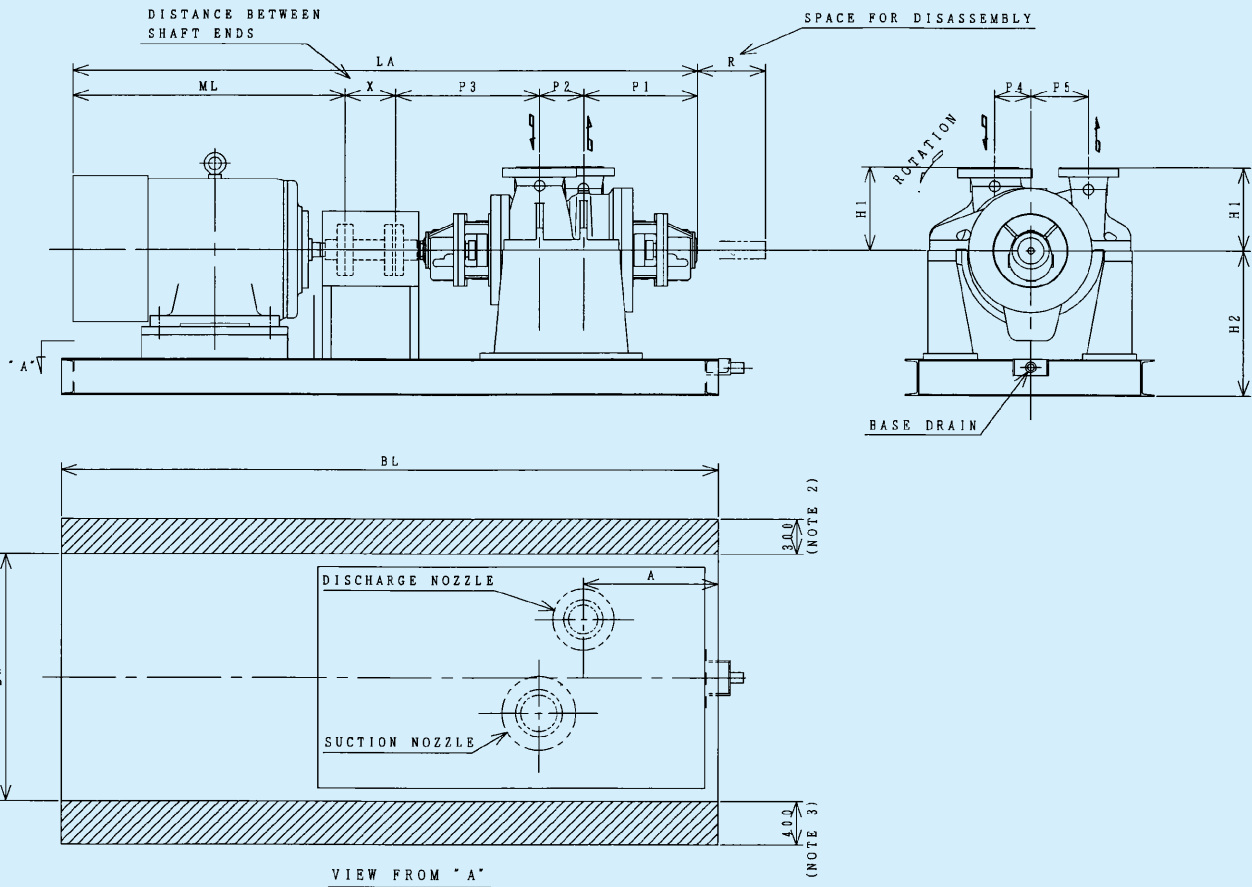

NOTE

1. THESE MEASUREMENTS ARE APPROXIMATE AND FOR REFERENCE.
2. WHEN MECHANICAL SEAL COOLER PROVIDED, PLEASE ADD 300mm TO THIS BW MEASUREMENT.
3. WHEN RESERVOIRS PROVIDED, PLEASE ADD 400mm TO THIS BW MEASUREMENT.

PUMP SIZE	PUMP AND MOTOR (mm)												BASE(mm)		APPROX WEIGHT(kg)	
	P ₁	P ₂	P ₃	P ₄	P ₅	H ₁	H ₂	X	ML	LA	R	A	BL	BW	PUMP	BASE
80×50 R2 33 70	538	130	585	140	165	300	630	250	996	2499	950	590	2920	1270	700	1300
100×80 R2 36 80	567	160	634	140	190	320	590	250	1619	3230	1050	610	3420	1400	980	1800
100×80 R2 40 80	559	145	625	200	220	340	680	250	1618	3197	1050	630	3490	1400	1100	1900
100×80 R2 45 90	648	180	721	192	226	410	750	350	1495	3394	1400	950	3500	1400	1900	1900
150×100 R2 42 90	599	185	676	220	225	360	720	240	1509	3209	1100	630	3530	1540	1200	2000
150×100 R2D 45 90	649	205	672	185	260	427	760	280	1509	3315	1200	650	3580	1600	1700	2000
200×150 R2D 44 100	650	230	782	230	250	370	780	250	1509	3421	1420	680	3700	1540	1300	2100
250×150 R2D 45 100	703	275	845	240	280	480	840	250	1774	3847	1500	780	4150	1800	1800	2200
250×200 R2D 70 120	899	305	948	245	400	640	1040	280	1764	4196	1600	920	4570	1980	2250	4000
250×200 R2D 72 120	970	350	972	275	445	600	1200	350	2245	4887	1500	1700	6000	2300	3800	5000
300×250 R2D 70 140	963	330	1000	300	425	700	1135	280	2610	5078	1800	1300	5600	2240	3000	4400

Note : Dimensions are in mm and for guidance only.

Certified drawings will be provided in all cases of actual construction. Motor dimensions are approximate.

The listed dimensions apply to roller/ball (ball/ball) bearing designs with the exception that the dimensions of 150×100 R2D 45, 250×150 R2D 45, 250×200 R2D 70, 250×200 R2D 72 and 300×250 R2D 70 are for sleeve/ball bearing designs.



EBARA CORPORATION

Head Office:

11-1, Haneda Asahi-cho, Ohta-ku,
Tokyo, 144-8510 Japan
Phone: 81-3-3743-6111
Fax: 81-3-3745-3356
Internet homepage : <http://www.ebara.co.jp>

Please send your enquiries to the above International Division

○: Liaison Offices

■ AMERICA

UNITED STATES OF AMERICA

Ebara International Corporation (Sparks, NV)

BRAZIL

Ebara Indústrias Mecánicas e Comércio Ltda.
(Bauru, S.P.)

■ EUROPE

ENGLAND

Elliott Turbomachinery Limited (Basingstoke)

ITALY

- Italy Office (Vicenza)
Ebara Pumps Europe S.p.A. (Trento)
Sumoto S.r.l. (Vicenza)

SPAIN

Ebara Espana Bombas S.A. (Madrid)

■ ASIA

PEOPLE'S REPUBLIC OF CHINA

- Beijing Office (Beijing)
Yantai Ebara Air Conditioning Equipment Co., Ltd.
(Yantai)
Ebara Machinery (Shanghai) Co., Ltd. (Shanghai)
Shanghai Ebara Engineering and Services Co., Ltd.
(Shanghai)

Ebara Qingdao Co., Ltd. (Qingdao)
Ebara Densan (Kunshan) Mfg. Co., Ltd. (Kunshan)

TAIWAN

- Taipei Office (Taipei)
Ebara-Densan Taiwan Manufacturing Co., Ltd.
(Chung Li)
Ebara-Elliott Service (Taiwan) Co., Ltd. (Taichung)

KOREA

Hyosung-Ebara Co., Ltd. (Seoul)

SINGAPORE

Ebara Engineering Singapore Pte. Ltd.
(Singapore)

MALAYSIA

Ebara Pumps Malaysia Sdn. Bhd (Selangor)
Ebara Environmental Engineering (Malaysia) Sdn. Bhd.
(Selangor)

PHILIPPINES

- Manila Branch Office (Manila)
Ebara Benguet, Inc. (Laguna)

VIETNAM

Ebara Hai Duong Company Ltd. (Hai Duong)
Ebara Vietnam Corporation (Hanoi)

THAILAND

- Bangkok Office (Bangkok)
Ebara (Thailand) Limited (Bangkok)

INDIA

Kirloskar Ebara Pumps Limited (Pune)

■ MIDDLE-EAST

United Arab Emirates

- Middle East Office (Dubai)

■ OCEANIA

AUSTRALIA

Ebara Pumps Australia Pty. Ltd. (Bayswater, Vic)